

2. Basic setup and usage





a. Power on, off, and put to sleep

1. To power on, press and hold power button for a few seconds until the boot logo is displayed, then let go of the button
2. To power off, press and hold power button for a few seconds until shutdown options are displayed, then let go of the button
3. Follow on-screen instructions
4. To put to sleep, press power button once

b. Start Screen

1. To access Start Screen, tap or click Windows icon 
2. The start screen is populated by available apps
3. To open app, tap or click app icon

c. Connect to Wi-Fi

1. Tap or click Windows button 
2. Tap or click Settings 
3. Tap or click Network & Internet 
4. Toggle Wi-Fi on 
5. Identify your Wi-Fi, and tap or click to connect
6. Enter password if prompted

3. Getting started



a. Navigate the Start Screen

1. Tap or click Windows button 
2. To open app, tap or click visible app icon
3. To view all installed apps, tap or click All apps button

b. Open a recently used app

1. Tap or click Task View 
2. All currently opened apps will be displayed
3. To bring an app to the foreground, tap or click that app
4. For additional options, hover cursor over app

c. Download a new app

1. Tap or click Windows button 
2. Tap or click Windows Store 
3. Search for app to install
4. Follow on-screen instructions
5. Once downloaded, app will appear in Start Screen

4. Charging your Seal

- Attach Type C USB cable to charging port on device
- Plug USB cable into computer USB port or accompanying wall charger

5. Listening to audio

- Open music app or audio file
- Audio will play natively through built-in speakers
- To adjust volume, turn volume buttons up or down

6. Transferring files to your device

- Connect USB device to USB 2.0 or 3.0 port or use SD Card
- Transfer files to and from device

7. Inserting SIM and SD cards

- Unscrew the battery (on back of device)
- Read the SIM and SD card labels
- Insert your SIM and SD cards
- Screw the battery back into the device



Disclaimer

Seal is a trademark of BAK USA Technologies Corp.
Windows 10 is a trademark of Microsoft Corp.

FC TABLET PC Model No: Seal 8 Pro
FCC ID: 2AEY7-S8A002

This device complies with part 15 of the FCC Rules. Operations is subject to the following two conditions: (1) This device may not cause harmful interference, and (2) this device must accept any interference received, including interference that may cause undesired operation.

FCC label can be located underneath the battery compartment.

BAK USA Technologies Corp.
Web: bakusa.com
Address: 425 Michigan Ave.
Buffalo New York, 14203

**Born in Buffalo.
Built for the World.**

SEAL

Quick Start Guide

For Windows 10

version 1.2

1. Seal at a glance

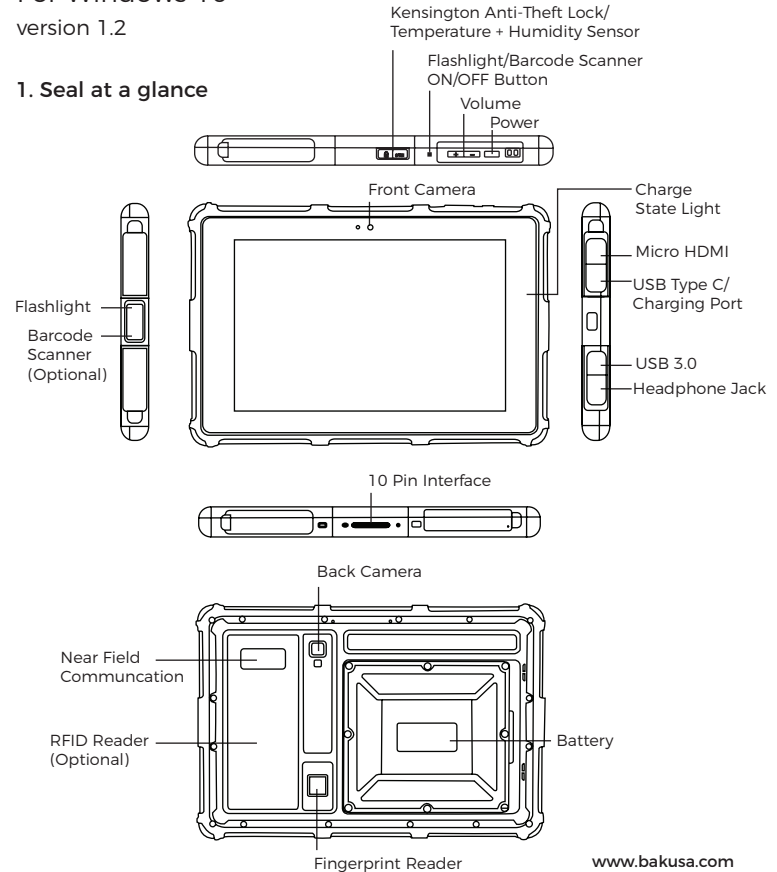

www.bakusa.com